

WOHNÜBERBAUUNG WOLFGANGHOF SÜD

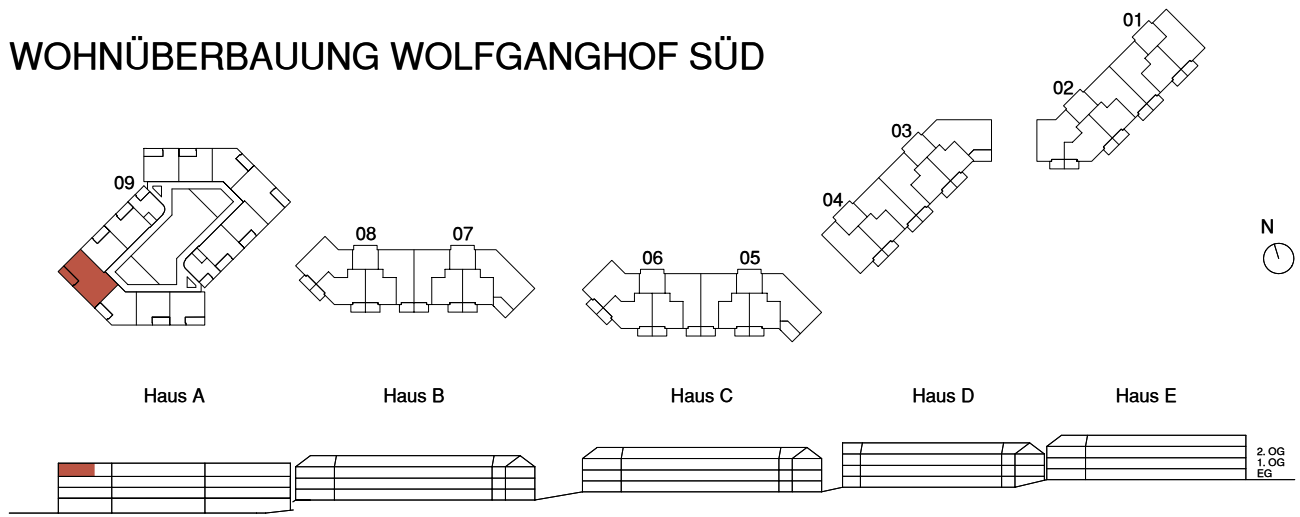

Adresse
Wolfgangstrasse 80, 9014 St. Gallen

Haus A

Stockwerk
3. Obergeschoss

Wohnung
09.3011

Anzahl Zimmer
3,5

Nettowohn-/ Balkonfläche
84.2 m² / 10.5 m²

